

# Play & Sell system<sup>®</sup>



**MORIS**  
DESIGN

# Play & Sell system

## **Set up your store in just a few clicks!**

The unique Play&Sell system offers equipment made of premium materials with a timeless design. The main elements are made to reflect the core market segments: groceries, hardline, health and beauty, and pharmacies. This allows Play&Sell to be used for any product portfolio.

Besides the standard equipment essentials for store operations, we also offer branding and POS communication features. You can use them to adapt your store to your brand, products, and business goals and make your POS communications with your customers more efficient. Digital technologies can be added to the standard equipment as well.

Thanks to the modular design of individual elements, the system adapts to any space. It is therefore suitable for smaller structured stores as well as for large sales areas.

The Play&Sell system brings you a fast and well-proven solution for your store without unnecessary costs.

- Suitable for all types of retail stores.
- The pure design will adapt to your brand.
- Everything you need for your store in one place.
- Better value for money than customised concepts.
- Products are in stock and available for immediate delivery.
- You can easily assemble the furniture yourself.
- Own branding is possible.
- Save on project costs.

***Modular store outfitting system  
with different finishes.***







Facade logos .....	4–7
Window display decals .....	8
Window display and entrance .....	9–19
Checkouts .....	20–32
Shelves and stands .....	33–50
Sale baskets .....	51
Stands for baskets .....	52
Store backrooms .....	53–57
Shelf wayfinding signage.....	58
POS equipment .....	59
Display tables .....	60



## T-board illuminated

One-sided on the facade

Product Name	Dimensions
T-board illuminated	1500x400
T-board illuminated	2000x400
T-board illuminated	2500x400
T-board illuminated	1500x500
T-board illuminated	2000x500
T-board illuminated	2500x500
T-board illuminated	1500x600
T-board illuminated	2000x600
T-board illuminated	2500x600
T-board illuminated	3200x1000
T-board illuminated	1200x1000





## T-board non-illuminated

One-sided on the facade

Product Name	Dimensions
T-board non-illuminated	1500x400
T-board non-illuminated	2000x400
T-board non-illuminated	2500x400
T-board non-illuminated	1500x500
T-board non-illuminated	2000x500
T-board non-illuminated	2500x500
T-board non-illuminated	1500x600
T-board non-illuminated	2000x600
T-board non-illuminated	2500x600



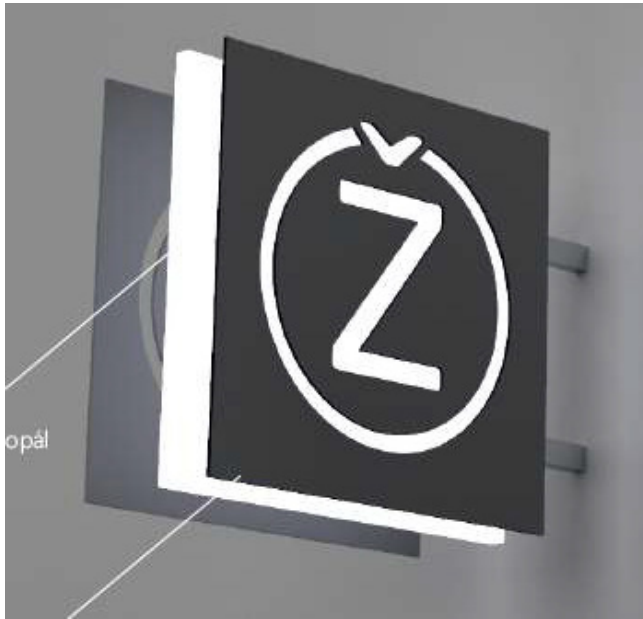

## Logo protruding

2D protruding, illuminated, square  
One-sided on the facade

Product Name	Dimensions
T-board protruding	500x500

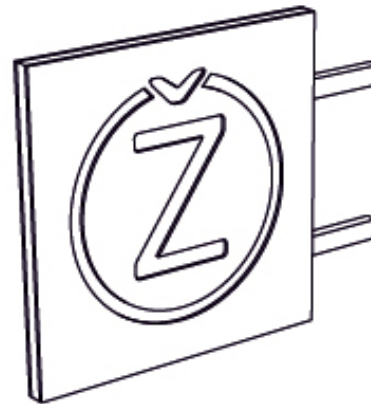
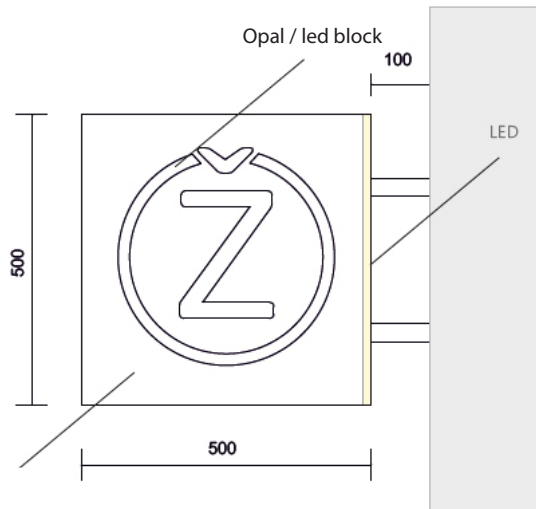

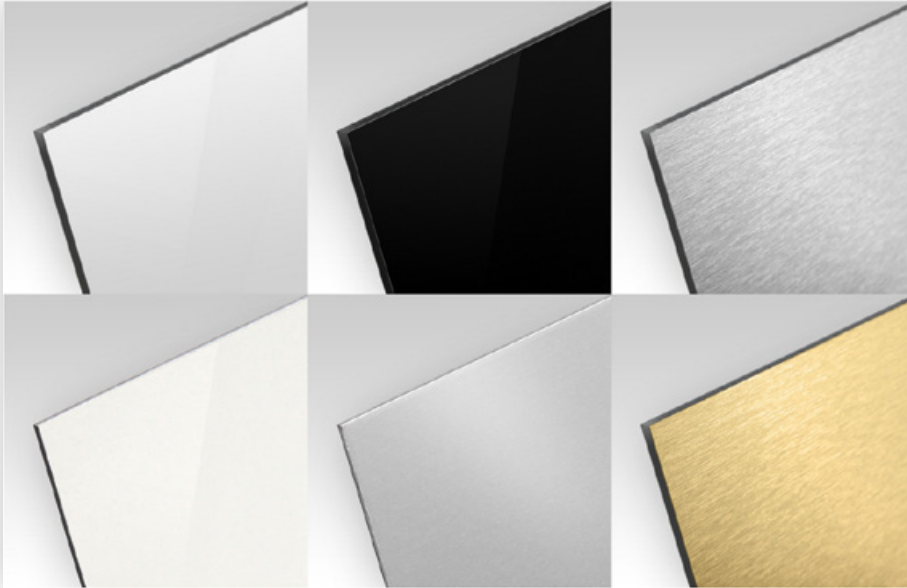

## Wall-mounted base plate with decal

Product Name	Dimensions
Plate with decal 1500x400	1500x400
Plate with decal 2000x400	2000x400
Plate with decal 2500x400	2500x400
Plate with decal 1500x500	1500x500
Plate with decal 2000x500	2000x500
Plate with decal 2500x500	2500x500
Plate with decal 1500x600	1500x600
Plate with decal 2000x600	2000x600
Plate with decal 2500x600	2500x600

Mamut 290 ml	
--------------	--

### Attachment:

Mamut 290 ml

Attachment set for T-board installation N/A





## Sale, special offer, new

self-adhesive film, test print must be made



Product Name	Dimensions
1-99 % Discount	D500 mm
1-99 % Discount	D1000 mm
New	D500 mm
New	D1000 mm
Sale	D500 mm
Sale	D1000 mm



Platforms and stands

## Stand A4 POS high

Product Name

Stand POS high

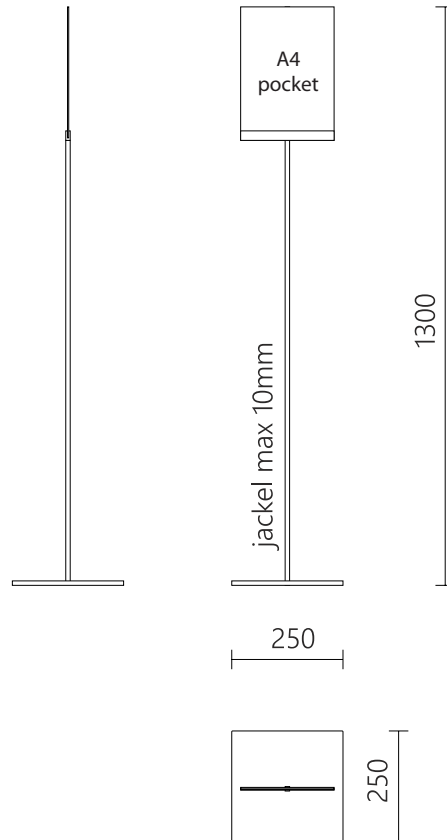



Platforms and stands

## A4 POS stand low

Product Name

Stand POS low

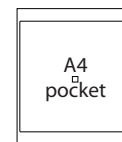
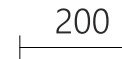
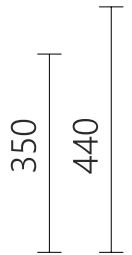
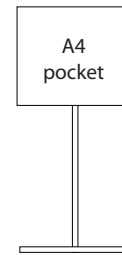
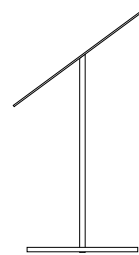



Platforms and stands

## Platform without POS

Product Name	Dimensions
Platform	800x500x150 mm

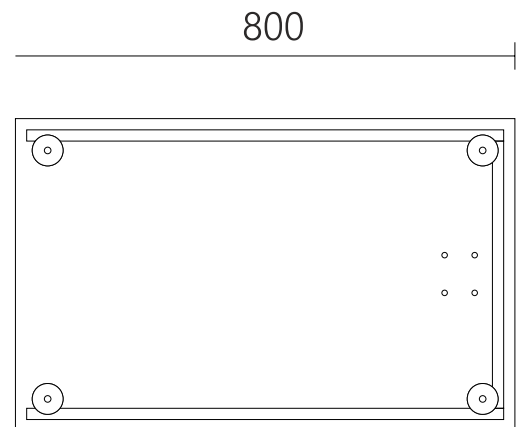
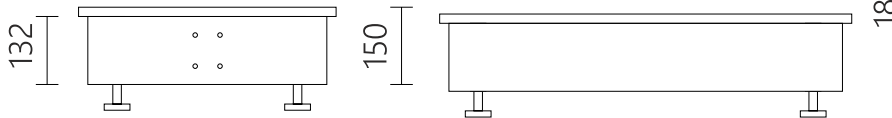



Platforms and stands

# Platform with POS

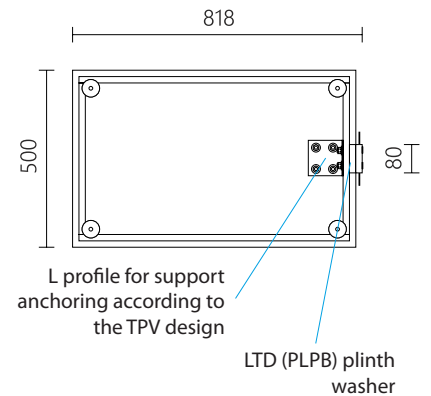
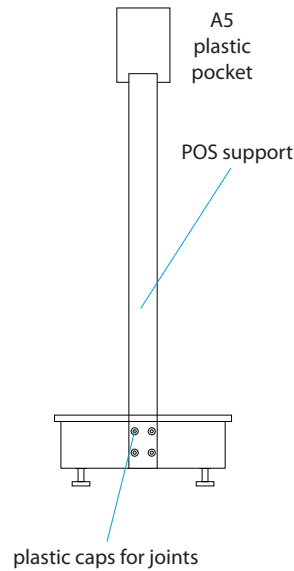
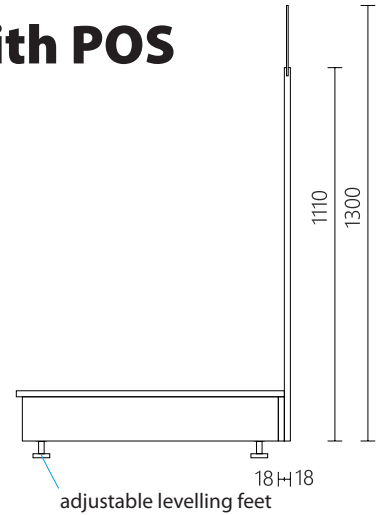



Platforms and stands

# Multi-purpose platform

Product Name	Dimensions
Multi-purpose platform	800x500x150 mm

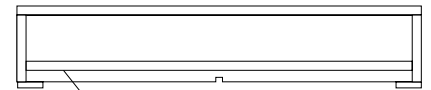

Second bottom with cut-outs for stands anch

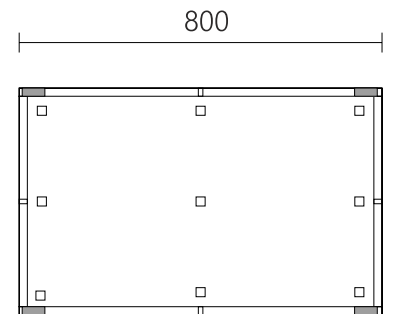
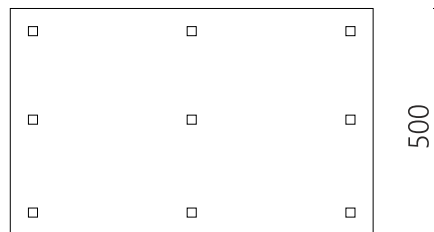
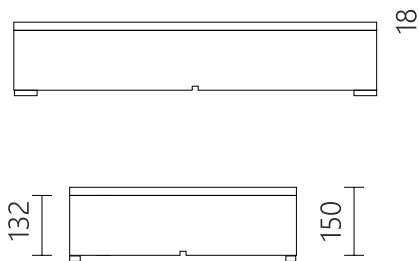



Platforms and stands

## Multi-purpose platform, sets – Set 1

Product Name	Dimensions
L stand POS A3	výška 1700 mm



L stand POS 1x A3

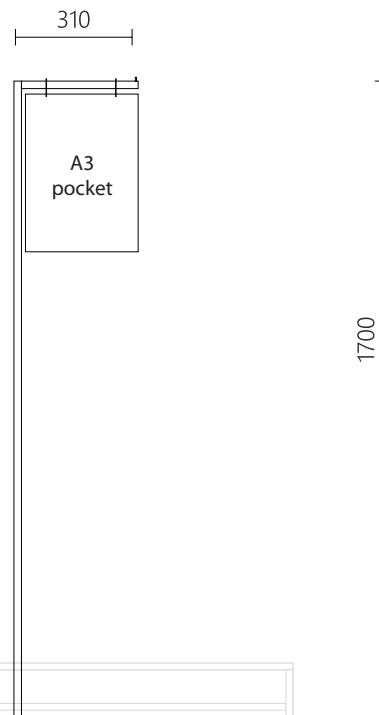



Platforms and stands

## Multi-purpose platform- Set 2

Product Name	Dimensions
T stand POS A3	height 1700 mm

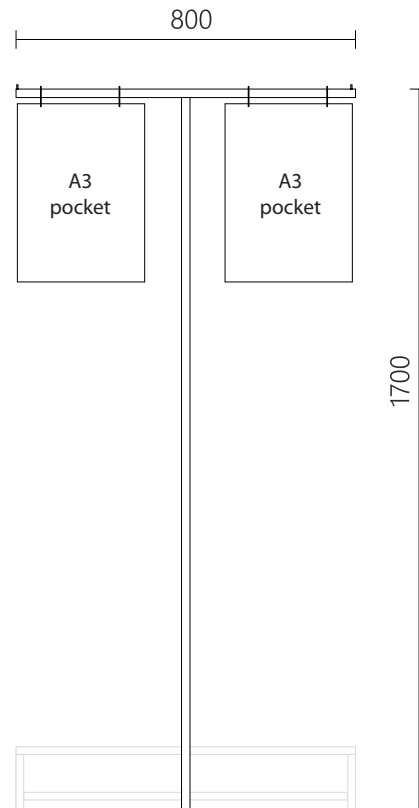





Platforms and stands

## Multi-purpose platform, sets – Set 3

Product Name	Dimensions
Metal arch large	1700x720x20
Metal arch medium	650x720x20
Metal arch small	400x720x20
Arch shelf middle	680x200x18
Arch shelf upper	720x200x18
Attachment	N/A

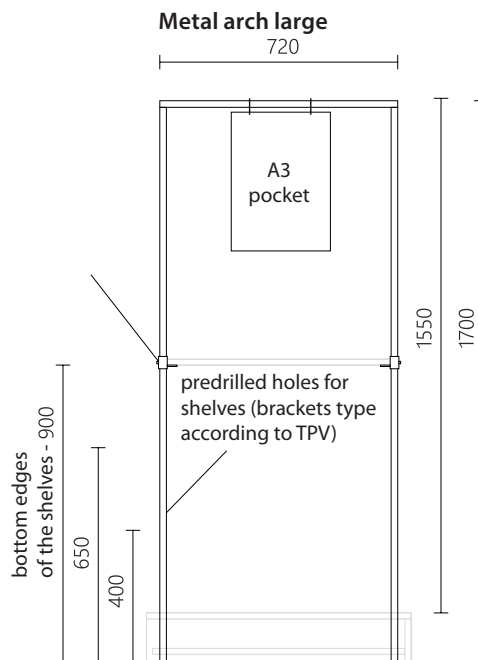



Platforms and stands

# Multi-purpose platform – accessories

Product Name	Dimensions
Supporting beam	680 mm
Arm	200 mm
Arm	400 mm
Arm Z	200 mm
Arm Z	400 mm

1. Supporting beam L 680 mm

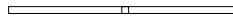

2. Supporting beam + small hooks



3. Supporting beam + arm 200 mm



4. Supporting beam + arm 2x 200 mm



5. Supporting beam + arm Z 200 mm

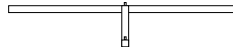

6. Supporting beam + arm Z 2x 200 mm



A1, A2, A3, A4, A5  
pet hanging pocket





Platforms and stands

## Multi-purpose platform, sets – accessories

Product Name	Dimensions
T-Board illuminated, for platforms, double-sided, with graphics	800x1500x55
T-board non-illuminated, for platforms, double-sided, with graphics	800x1500x55

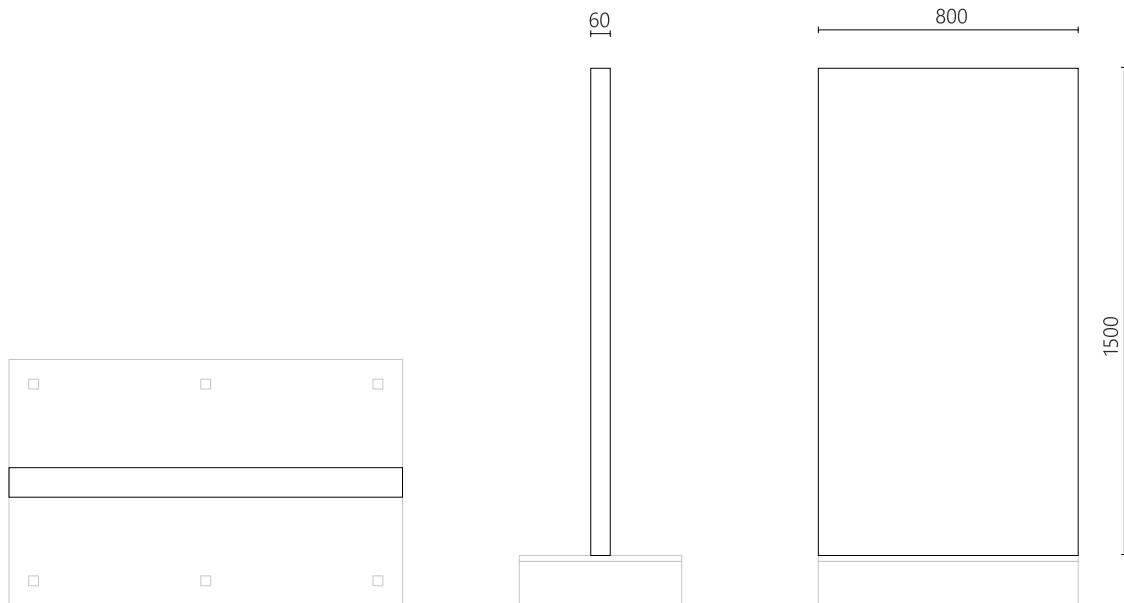



POS support

## **T-board one-sided, suspended**

Product Name	Dimensions
T-Board illuminated with graphics	800x1500x55
T-Board non-illuminated with graphics	800x1500x55

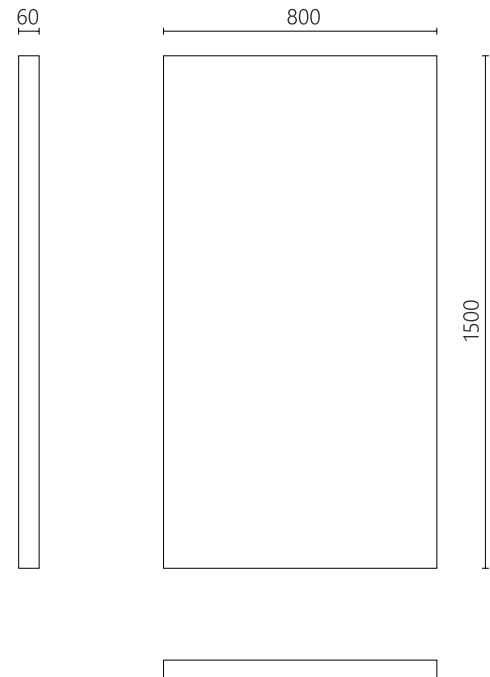



Checkout zone

## Checkout set 1

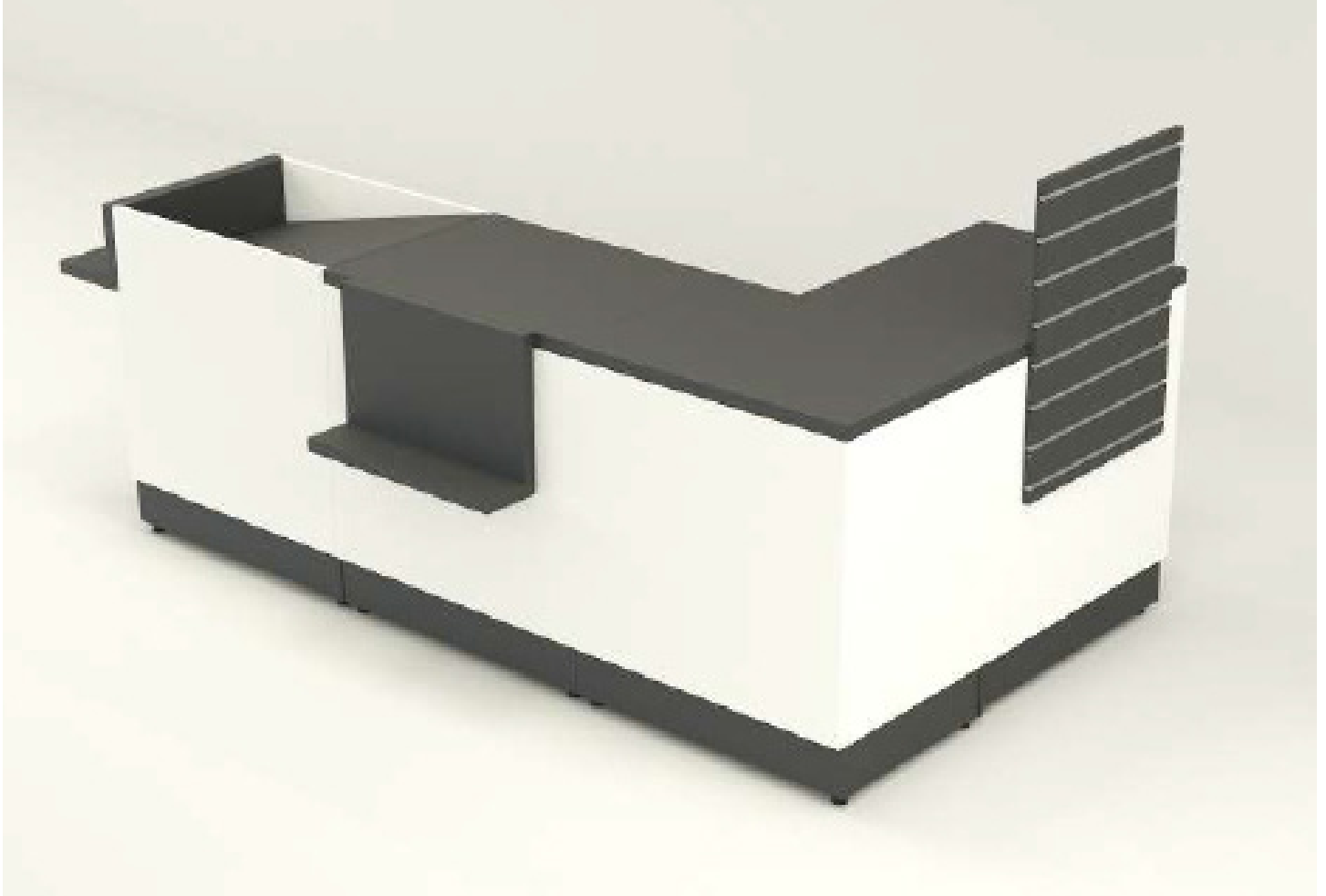

Set with slope without rear counter



Checkout zone

## Checkout set 2



Set with small rear counter and image graphics



Checkout zone

## Checkout set 3



Impulse rear counter set with sale graphics



Checkout zone

## Definition of terms



Checkout T-board graphics

Top header

Impulse buy arch

Impulse buy rear counter

Anticovid shield

Impulse buy front

Storage module

Checkout module

Glazed module

Checkout counter high

Checkout counter low





Checkout zone

## List of checkout elements that can also be sold separately

Product Name	Dimensions
Checkout set 1	1200 Left
Checkout set 1	1200 Right
Checkout set 2	1200 Left
Checkout set 2	1200 Right
Checkout set 3	1200 Left
Checkout set 3	1200 Right
Checkout with slope	1200 Left
Checkout with slope	1200 Right
Checkout 1200	1200x900x600 mm Left
Checkout 1200	1200x900x600 mm Right

Product Name	Dimensions
Checkout counter 1200	High
Checkout counter 1200	Low
T-Board illuminated	3200 3200x1000 mm
T-Board illuminated	1200 1200x1000 mm
Storage 1200	1200x600x900 mm
Impulse buy rear counter	1200 1200x1050x120 mm
Front impulse 1000	600x780 mm
Terminal and screen holder	N/A
Screen holder	N/A
Corner module	600x600x900

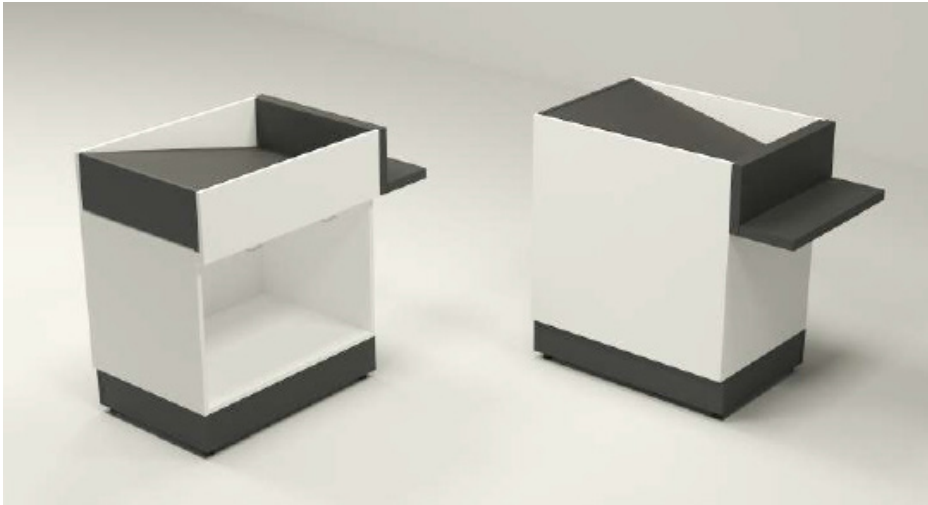

Checkout zone

# Checkout module with slope 1200

Right and left version

The upper part of the module can be handled separately - depending on the checkout orientation to the right or left side

The bottom of the slope is made of HPL (high pressure laminate)

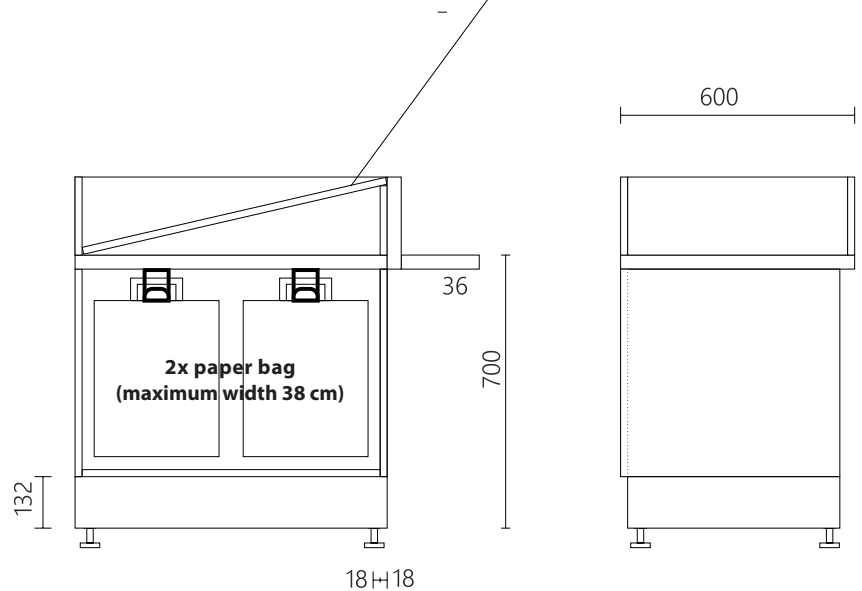
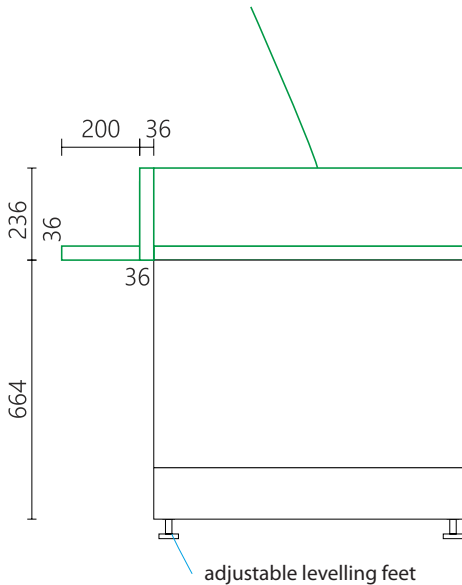



Checkout zone

## Checkout module with front 1200

Right and left version

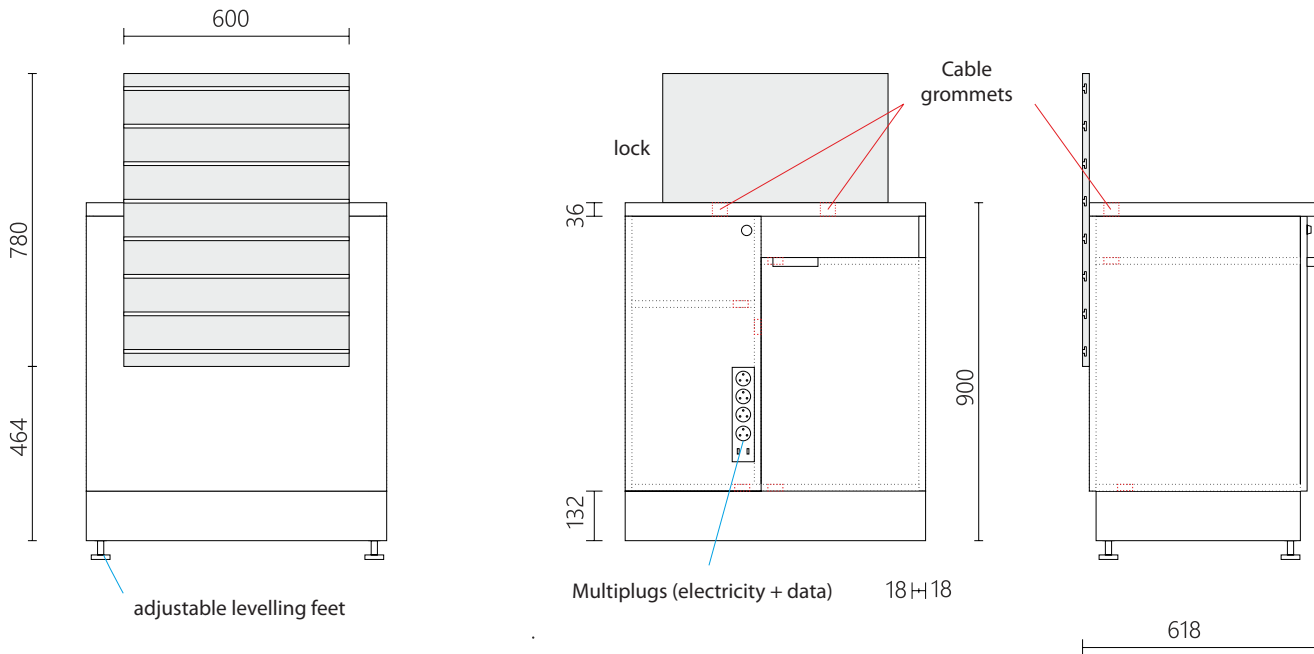



Checkout zone

# Checkout counter module high 1200

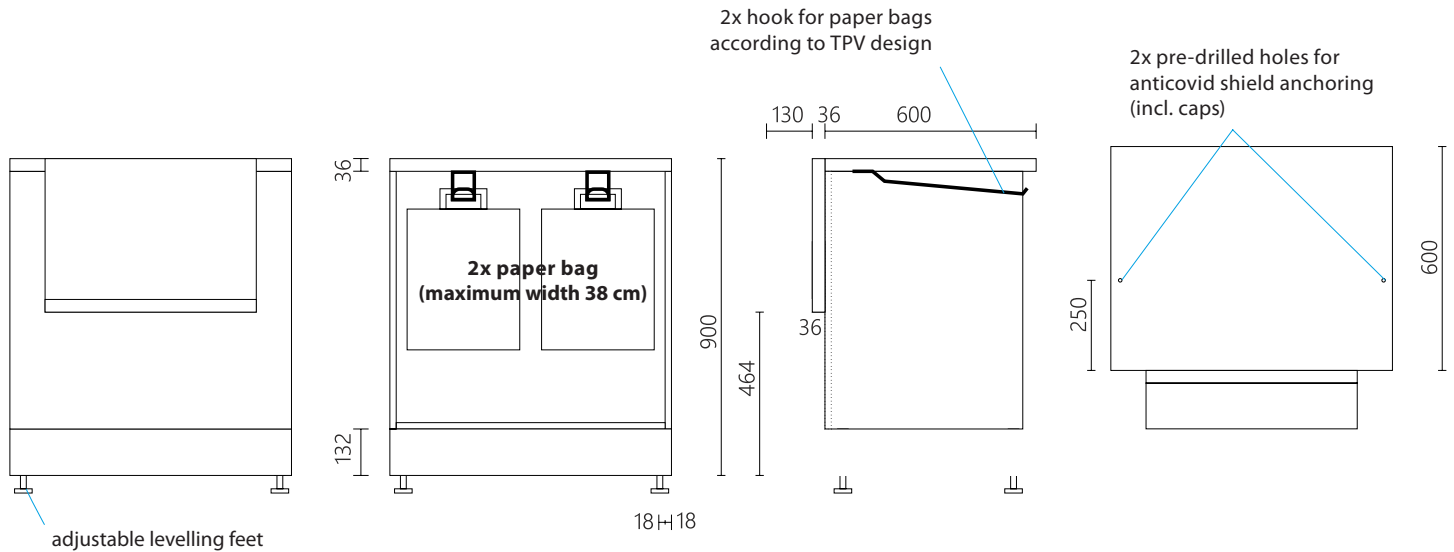



Checkout zone

# Checkout counter module low 1200

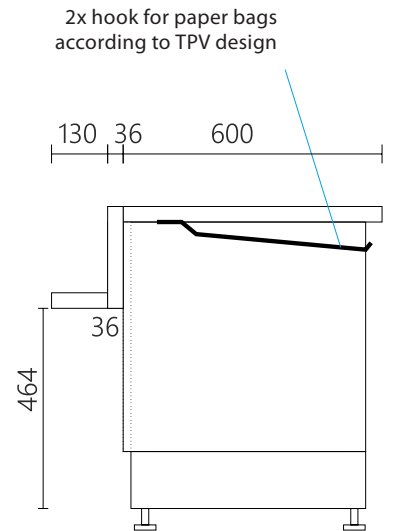
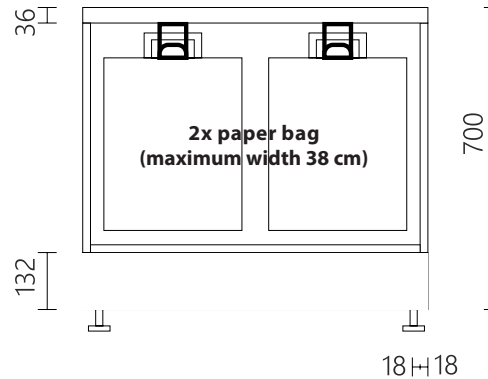
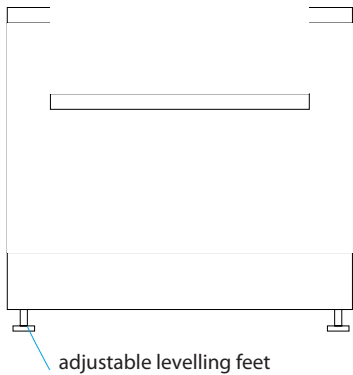



Checkout zone

# Storage checkout module 1200

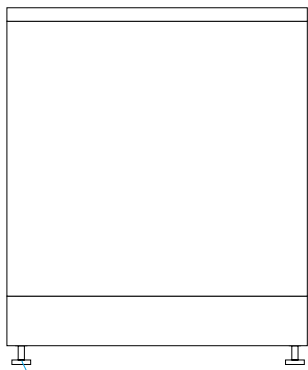

adjustable levelling feet

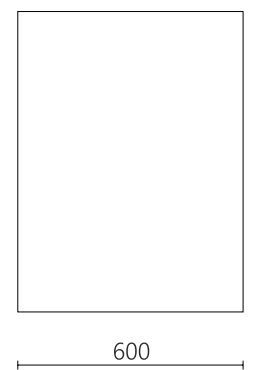
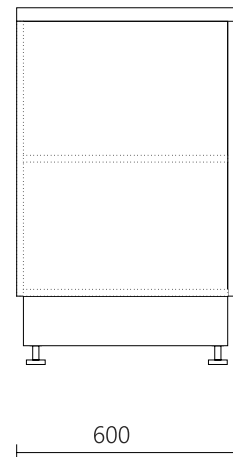
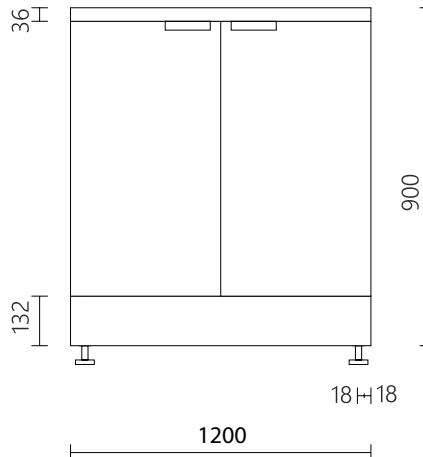



Checkout accessories

# Impulse buy rear counter 1200

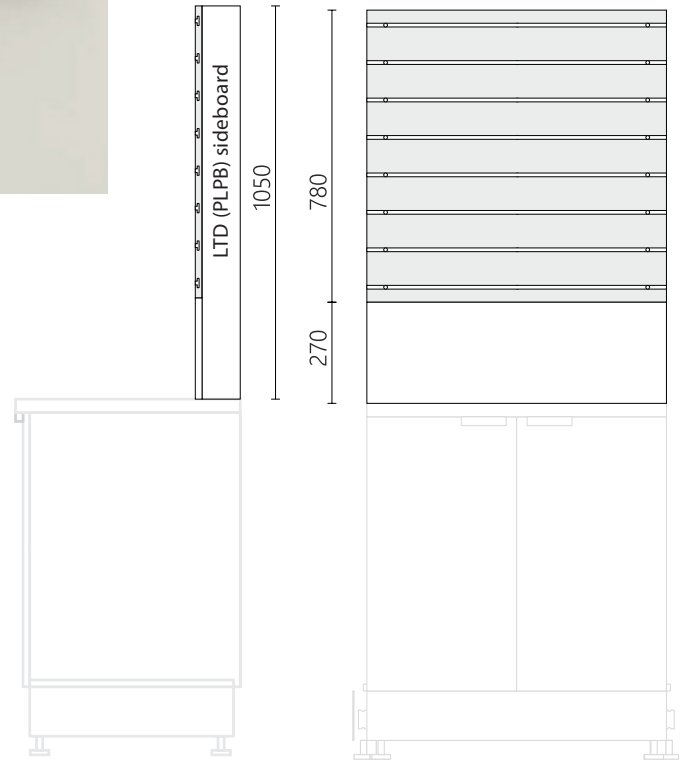
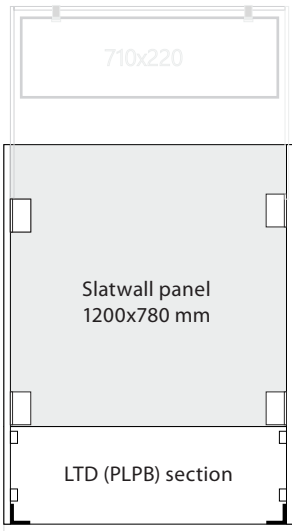



Checkout accessories

# Front impulse buy 1000

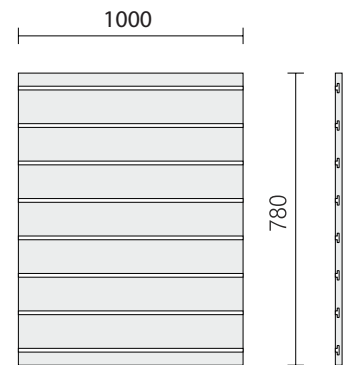





Checkout accessories

## Terminal and screen holder

Terminal and screen holder

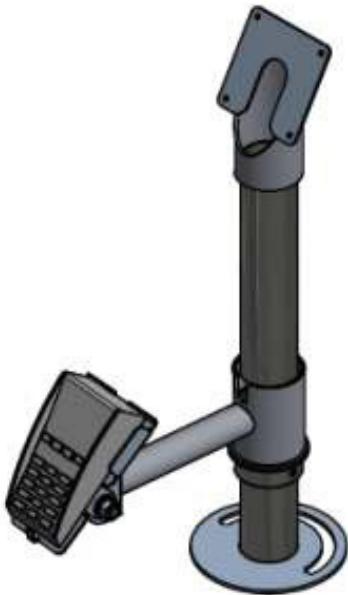

Screen holder





Impulse buys

# Gondola sets for impulse buys 1000

Product Name	Dimensions
Impulse gondola front SW 400	500x1348x250 mm
Impulse gondola module 1000	1.000x1348x500 mm
Impulse gondola module 1000 IG1	1.000x1348x500 mm
Impulse gondola module 1000 IG2	2.000x1348x500 mm
Impulse gondola module 1000 IG3	3.000x1348x500 mm
Impulse gondola module 1000 IG4	4.000x1348x500 mm

Product Name	Dimensions
Impulse gondola module 1000 IG5	5.000x1348x500 mm
Impulse gondola module 1000 IG6	6.000x1348x500 mm
Impulse gondola module 1000 IG7	7.000x1348x500 mm
Impulse gondola module 1000 IG8	8.000x1348x500 mm
Impulse gondola module 1000 IG9	9.000x1348x500 mm
Impulse gondola module 1000 IG10	10.000x1348x500 mm



Impulse buys

# Impulse buy gondola sets 1000

Dimensions

### Impulse gondola module

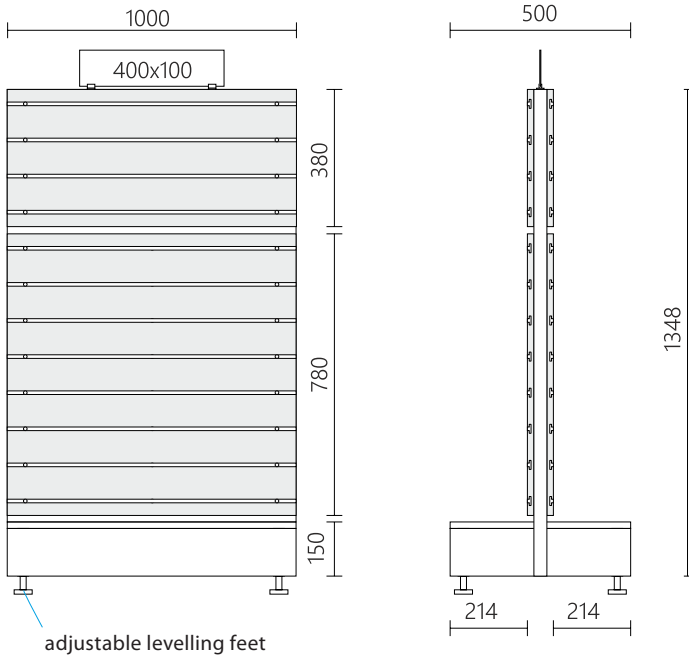

### Impulse gondola front

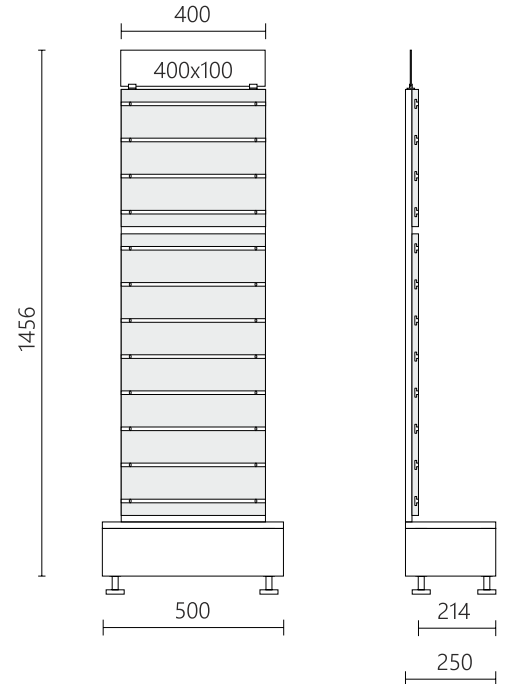



Impulse buys

# Gondola sets

Accessories

Product Name	Dimensions
LTD impulse shelf 800	800x18x150 mm
LTD impulse shelf 400	400x18x150 mm
LTD impulse shelf 500	500x18x150 mm
LTD impulse shelf 500	500x18x200 mm
LTD impulse shelf 1000	1000x18x150 mm
Shelf bracket for SW Left	150 mm

Product Name	Dimensions
Shelf bracket for SW Right	150 mm
Hook with price tag for SW	150 mm
Hook with price tag for SW	150 mm
Hook without price tag for SW	150 mm
Hook without price tag for SW	150 mm



Impulse buys

## Floor stand

Product Name	Dimensions
Floor stand for impulse buys	500x500x1340 mm

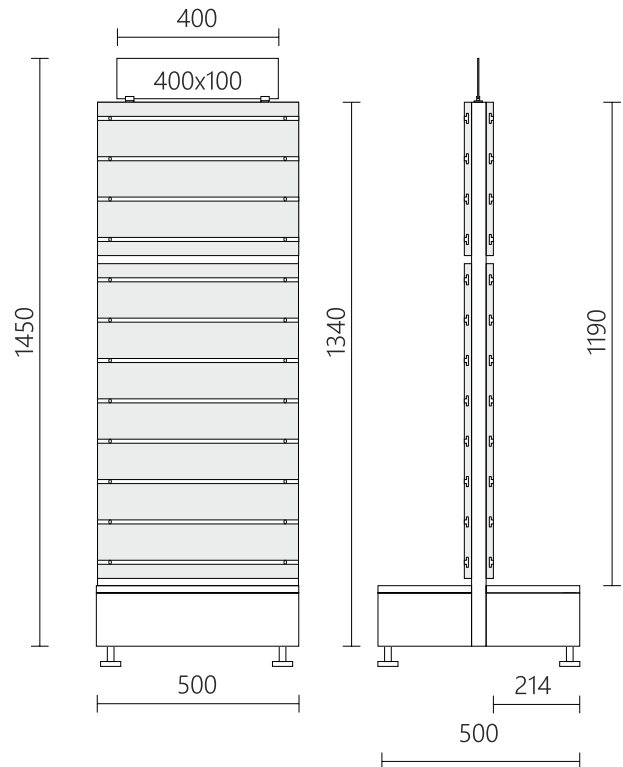



Impulse buys

# Impulse buy multistand

## Standard with hooks

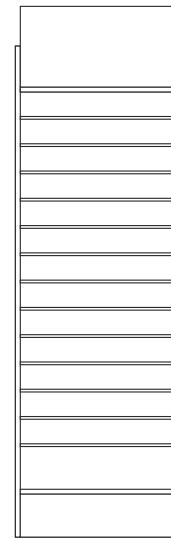

600

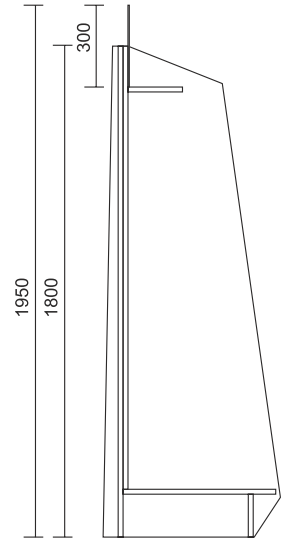

650

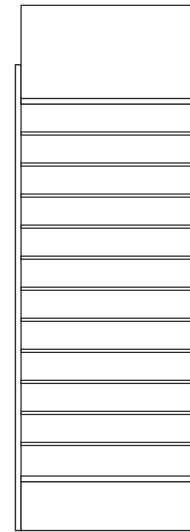

600

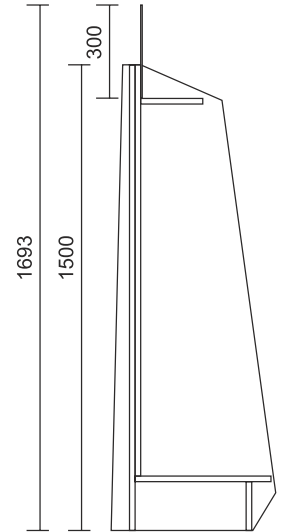

530

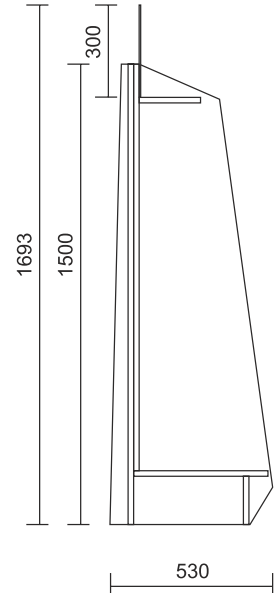
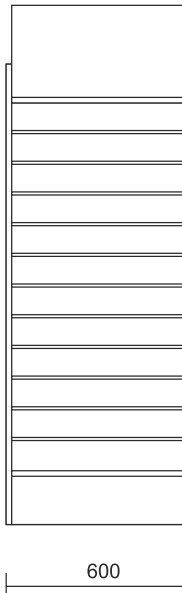
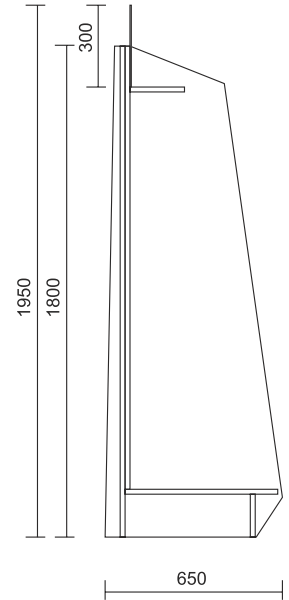
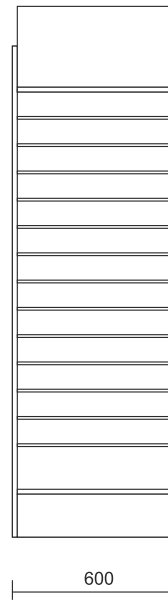

Impulse buys

# Impulse buy multistand

**Premium** with hooks



Impulse buys

# Impulse buy multistand

## Standard with shelves

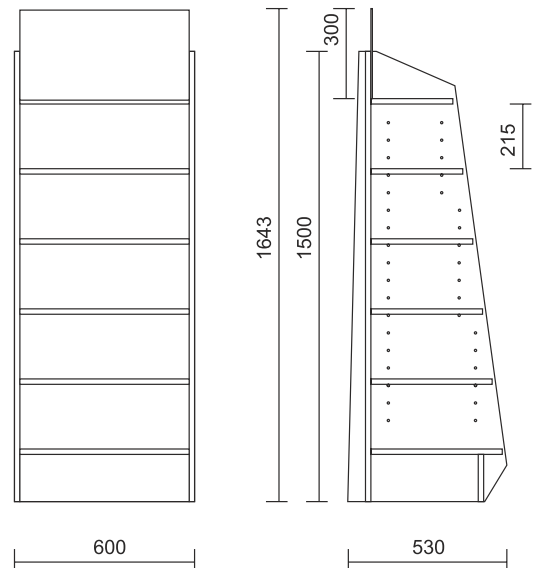
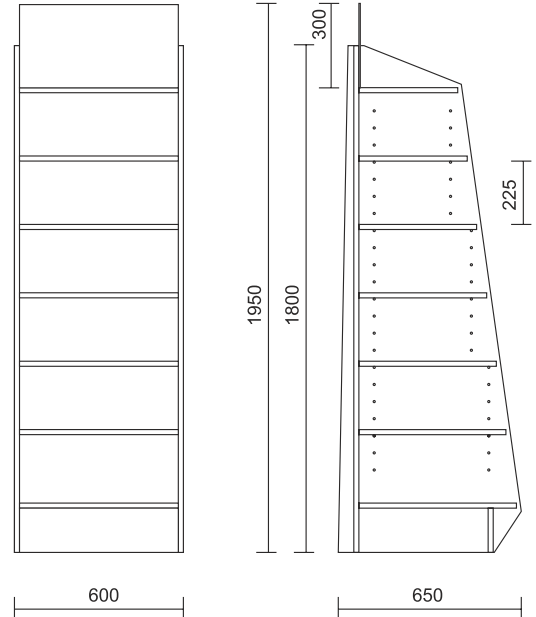



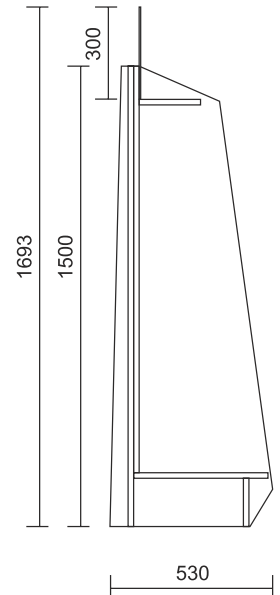
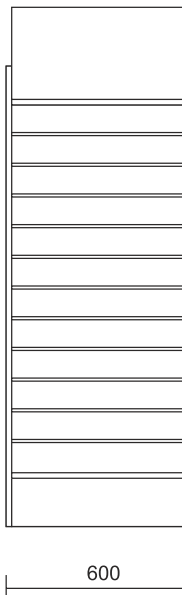
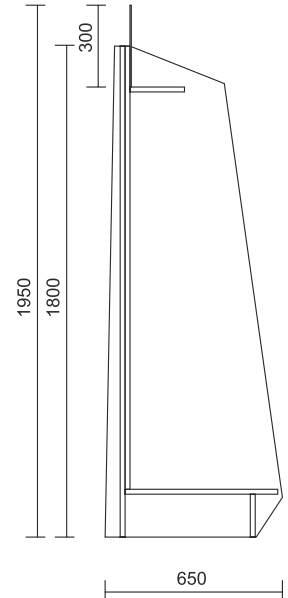
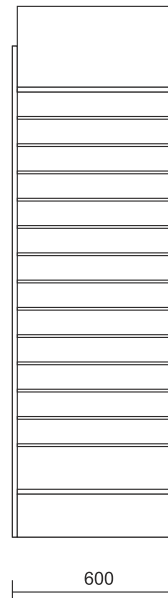

Impulse buys

# Impulse buy multistand

**Premium** with shelves



1000x2000 mm



Wall shelving

## Shelf sets – Low set

1000x2000 mm

### Set with slatwall panel 1–10 shelves

Product Name	color design
Shelf set low / 1000 SW RSN1	white finish
Shelf set low / 1000 SW RSN2	white finish
Shelf set low / 1000 SW RSN3	white finish
Shelf set low / 1000 SW RSN4	white finish
Shelf set low / 1000 SW RSN5	white finish
Shelf set low / 1000 SW RSN6	white finish
Shelf set low / 1000 SW RSN7	white finish
Shelf set low / 1000 SW RSN8	white finish
Shelf set low / 1000 SW RSN9	white finish
Shelf set low / 1000 SW RSN10	white finish
Shelf set low / 1000 SW RSN1	wood finish
Shelf set low / 1000 SW RSN2	wood finish
Shelf set low / 1000 SW RSN3	wood finish
Shelf set low / 1000 SW RSN4	wood finish
Shelf set low / 1000 SW RSN5	wood finish
Shelf set low / 1000 SW RSN6	wood finish
Shelf set low / 1000 SW RSN7	wood finish
Shelf set low / 1000 SW RSN8	wood finish
Shelf set low / 1000 SW RSN9	wood finish
Shelf set low / 1000 SW RSN10	wood finish



1000x2000 mm



Illustrative photo



Illustrative photo

Wall shelving

# Regálové sestavy

## – Low set

Set with full back panel 1–10 shelves

Product Name	color design
Shelf set low / 1000 Full back RSN1	white finish
Shelf set low / 1000 Full back RSN2	white finish
Shelf set low / 1000 Full back RSN3	white finish
Shelf set low / 1000 Full back RSN4	white finish
Shelf set low / 1000 Full back RSN5	white finish
Shelf set low / 1000 Full back RSN6	white finish
Shelf set low / 1000 Full back RSN7	white finish
Shelf set low / 1000 Full back RSN8	white finish
Shelf set low / 1000 Full back RSN9	white finish
Shelf set low / 1000 Full back RSN10	white finish
Shelf set low / 1000 Full back RSN1	wood finish
Shelf set low / 1000 Full back RSN2	wood finish
Shelf set low / 1000 Full back RSN3	wood finish
Shelf set low / 1000 Full back RSN4	wood finish
Shelf set low / 1000 Full back RSN5	wood finish
Shelf set low / 1000 Full back RSN6	wood finish
Shelf set low / 1000 Full back RSN7	wood finish
Shelf set low / 1000 Full back RSN8	wood finish
Shelf set low / 1000 Full back RSN9	wood finish
Shelf set low / 1000 Full back RSN10	wood finish



Wall shelving

# Shelf accessories

Bracket for slatwall

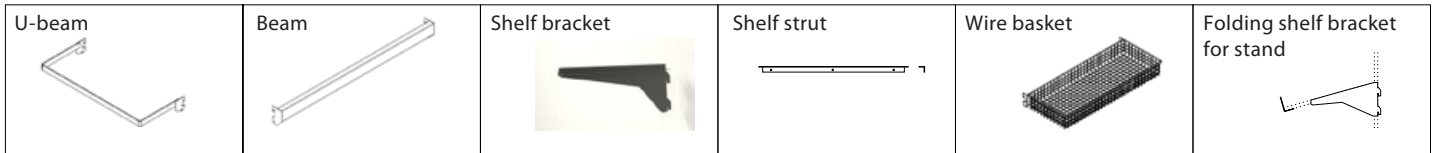

Product Name	Dimensions
Hook attached to stand for SW	780 mm
Hook attached to stand for SW	380 mm
Hook attached to stand for SW	280 mm
Supporting U-beam for stand	1000 mm
Supporting U-beam for stand	1000 mm
Supporting beam for stand	1000 mm
Supporting beam for stand	1000 mm
Arm	150 mm
Arm	150 mm
Arm	200 mm
Arm	400 mm
Arm for SW	150 mm
Arm for SW	150 mm
Arm for SW	200 mm
Arm for SW	200 mm
Arm for SW	400 mm
Arm for SW	400 mm
Hook with price tag for SW	200 mm
Hook with price tag for SW	200 mm
Hook with price tag for SW	300 mm
Hook with price tag for SW	300 mm

Product Name	Dimensions
Hook without price tag for SW	200 mm
Hook without price tag for SW	200 mm
Hook without price tag for SW	300 mm
Hook without price tag for SW	300 mm
Shelf LTD 1000	300 mm
Shelf LTD 1000	300 mm
Shelf LTD 1000	300 mm
Shelf LTD 1000	400 mm
Shelf LTD 1000	400 mm
Shelf LTD 1000	400 mm
Shelf LTD 1000	500 mm
Shelf LTD 1000	500 mm
Shelf LTD 1000	500 mm
Shelf bracket for stand, left	300 mm
Shelf bracket for stand, left	300 mm
Shelf bracket for stand, right	300 mm
Shelf bracket for stand, right	300 mm
Shelf bracket for stand, left	400 mm
Shelf bracket for stand, left	400 mm
Shelf bracket for stand, right	400 mm
Shelf bracket for stand, right	400 mm



Wall shelving

## Shelf accessories

Stock storage space

Product Name	Dimensions
Stock storage space 1000	1000x500x418 mm

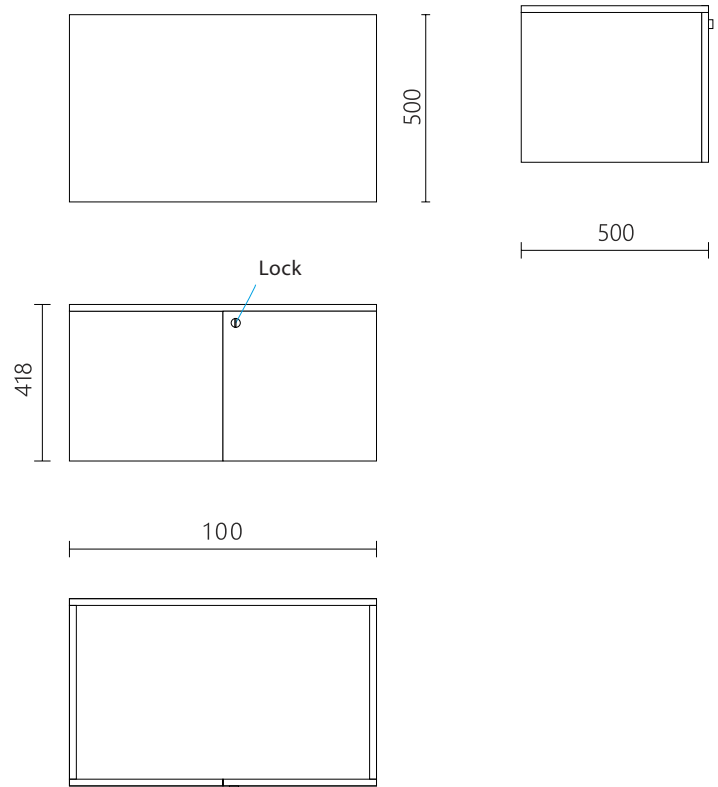



Wall shelving

## Shelf accessories

Stock storage drawer

Product Name	Dimensions
Stock storage drawer 1000	1000x400x132 mm

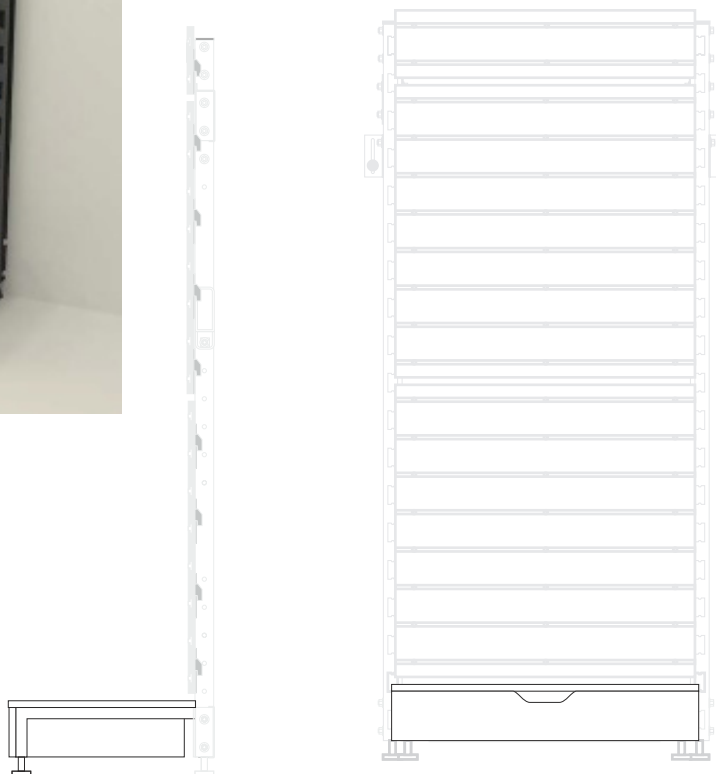
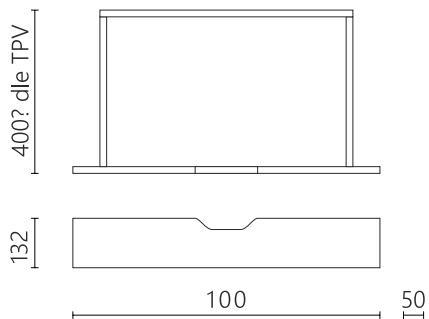



Wall shelving

## Shelf accessories

Stock storage shelves

Product Name	Dimensions
Stock storage shelves 1000	1000x400x100 mm

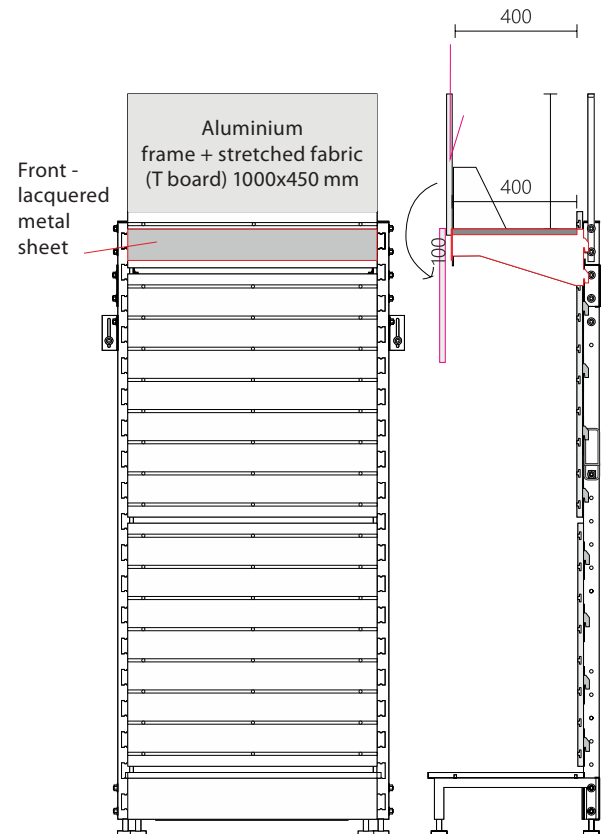

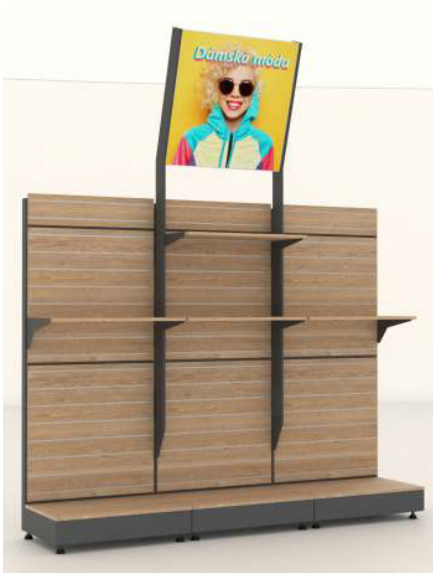

Wall shelving

# Shelf accessories

Promo frame tilted 400/800/1200

Shelf rack with illuminated signage  
1000 RSN1 + T-board. White finish.

Shelf rack with illuminated signage  
1000 RSN1 + T-board. Wood finish.

T board depending on the module width, fixed into the stand of the arch (according TPV design).

The anchors of the arch to the middle of the arch according the TPV design - it will pass the arch among the shelves of the stands too.

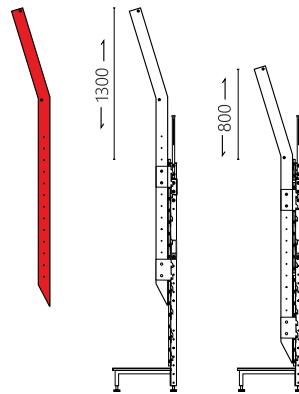
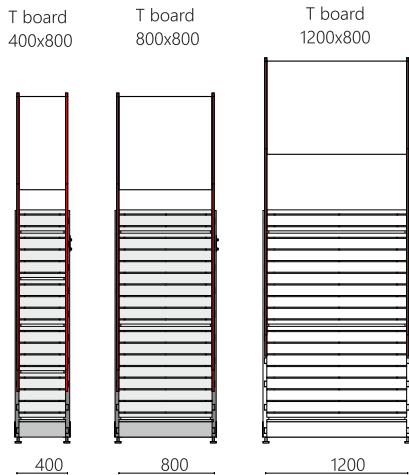

Same gate for different stand heights and flexible extension above the top edge of the stand, depending on the height of the top stock

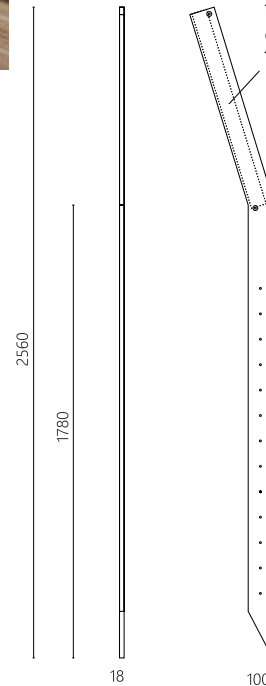

According TPV design - even the brackets for shelves to stands have to fit there





Divider KD series



Stock pusher „Push VI“, narrow, with high stop



Divider rail PEK with magnetic tape



Divider SR series, slanted, without stopper



Divider MP series, slanted, without stopper



Stock pusher „Push IV“, wide, without stopper.



Rear support



Slip brake



Shelf divider ROS series, height 60 mm, without stopper

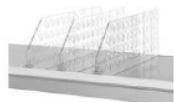

Shelf divider ROS series, height 140 mm, without stopper



Stopper rail



Fixing rail



ROS series accessories



Shelf divider ROS series, height 25 mm, without stopper

Wall shelving

# Shelf accessories

## Shelf equipment

Product Name	Dimensions
Price tag holder standard	65x39 mm
Price tag holder standard	398x39 mm
Price tag holder standard	1000x39 mm
Price tag holder with T	65x39 mm
Price tag holder with T	398x39 mm
Price tag holder with T	1000x39 mm
Price pocket for hook	69x39 mm
Self-adhesive item divider	300 mm
Self-adhesive item divider	400 mm
Self-adhesive item divider	500 mm
Item divider for T-bar	300 mm
Item divider for T-bar	400 mm
Item divider for T-bar	500 mm



Free-standing gondolas

# Free-standing gondolas – High set

**Option 1** – with slatwall panels and shelves 1–10

Product Name	Dimensions
Gondola set high / 1000 SW GSV1	white finish
Gondola set high / 1000 SW GSV2	white finish
Gondola set high / 1000 SW GSV3	white finish
Gondola set high / 1000 SW GSV4	white finish
Gondola set high / 1000 SW GSV5	white finish
Gondola set high / 1000 SW GSV6	white finish
Gondola set high / 1000 SW GSV7	white finish
Gondola set high / 1000 SW GSV8	white finish
Gondola set high / 1000 SW GSV9	white finish
Gondola set high / 1000 SW GSV10	white finish
Gondola set high / 1000 SW GSV1	wood finish
Gondola set high / 1000 SW GSV2	wood finish
Gondola set high / 1000 SW GSV3	wood finish
Gondola set high / 1000 SW GSV4	wood finish
Gondola set high / 1000 SW GSV5	wood finish
Gondola set high / 1000 SW GSV6	wood finish
Gondola set high / 1000 SW GSV7	wood finish
Gondola set high / 1000 SW GSV8	wood finish
Gondola set high / 1000 SW GSV9	wood finish
Gondola set high / 1000 SW GSV10	wood finish



Free-standing gondolas

# Free-standing gondolas – High set

**Option 2** – with full panels and shelves 1–10

Product Name	Dimensions
Gondola set high / 1000 Full back GSV1	white finish
Gondola set high / 1000 Full back GSV2	white finish
Gondola set high / 1000 Full back GSV3	white finish
Gondola set high / 1000 Full back GSV4	white finish
Gondola set high / 1000 Full back GSV5	white finish
Gondola set high / 1000 Full back GSV6	white finish
Gondola set high / 1000 Full back GSV7	white finish
Gondola set high / 1000 Full back GSV8	white finish
Gondola set high / 1000 Full back GSV9	white finish
Gondola set high / 1000 Full back GSV10	white finish
Gondola set high / 1000 Full back GSV1	wood finish
Gondola set high / 1000 Full back GSV2	wood finish
Gondola set high / 1000 Full back GSV3	wood finish
Gondola set high / 1000 Full back GSV4	wood finish
Gondola set high / 1000 Full back GSV5	wood finish
Gondola set high / 1000 Full back GSV6	wood finish
Gondola set high / 1000 Full back GSV7	wood finish
Gondola set high / 1000 Full back GSV8	wood finish
Gondola set high / 1000 Full back GSV9	wood finish
Gondola set high / 1000 Full back GSV10	wood finish



Sales baskets

# Wire basket for platforms

Product Name	Dimensions
Wire basket for platforms	800x500x950 mm
Wire basket for platforms	1000x800x950 mm

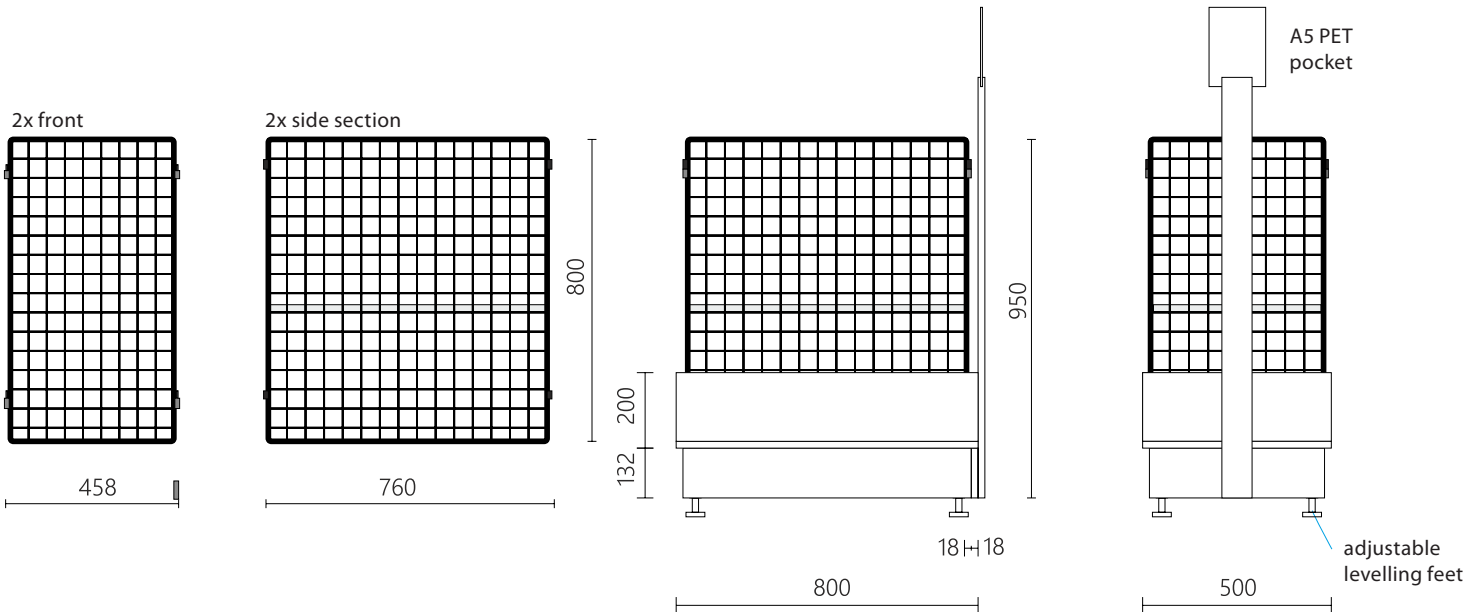



Platforms and stands

# Stand with leaflets and baskets

Product Name	Dimensions
Stand with leaflets and baskets	600x500x1840 mm

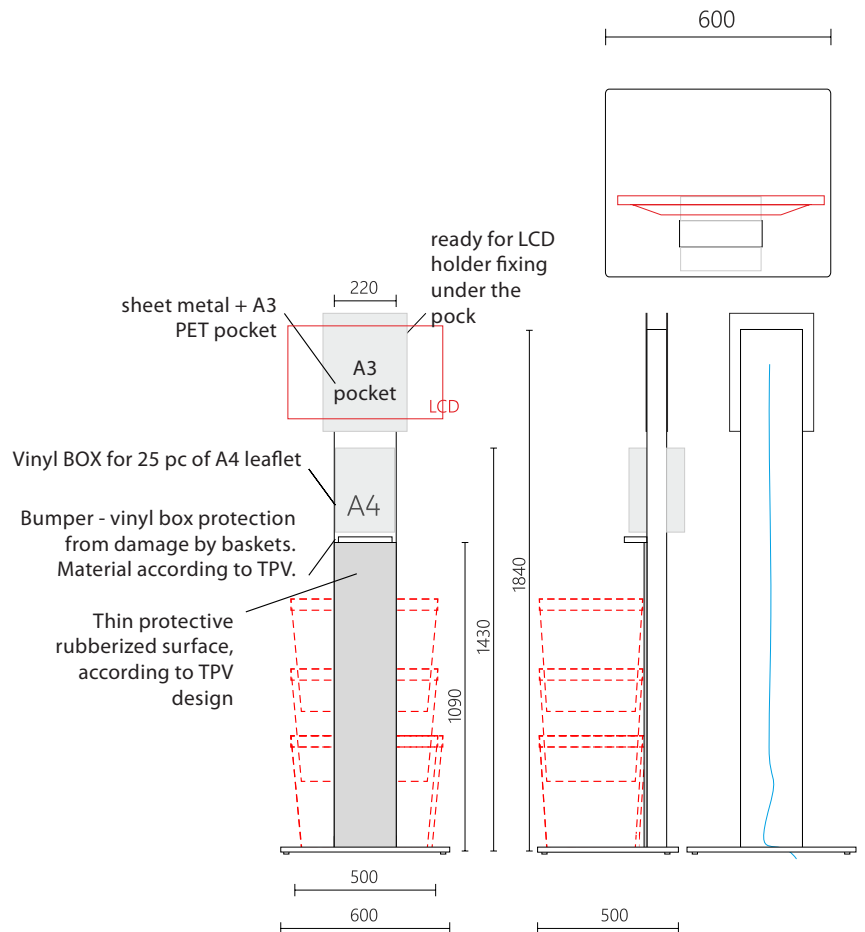



Kitchen

## **Kitchen**

**set 1**

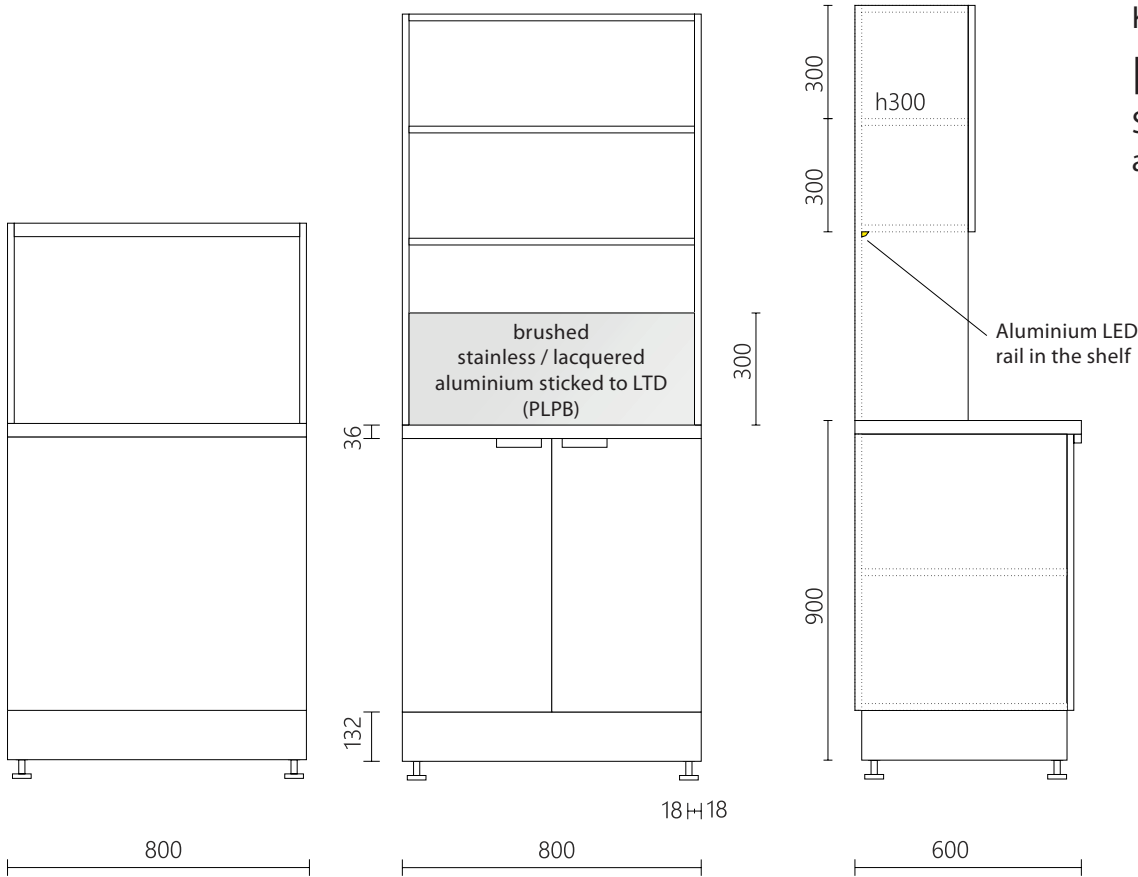

Kitchen

# Kitchen set 1

Set Dimensions  
and accessories





Kitchen

**Kitchen**

**set 2**



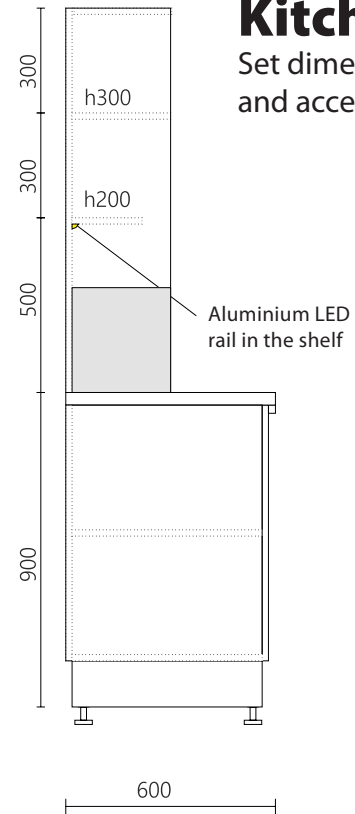
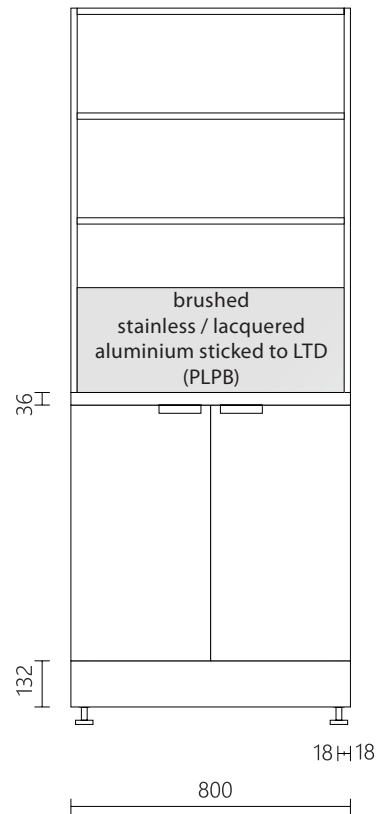
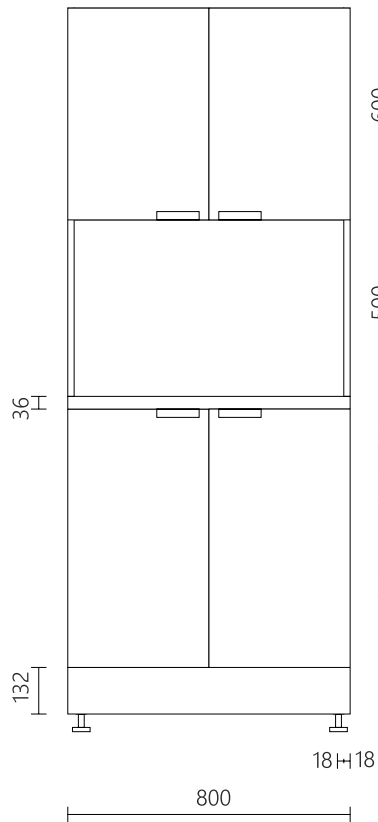

## Kitchen set 2

Set dimensions and accessories





## Locker

Product Name	Dimensions
Kitchen Set 1	White
Kitchen Set 2	White
Locker N/A	White

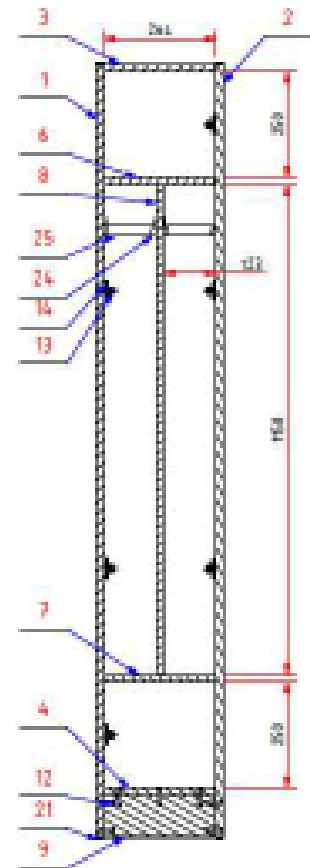



## Upper header sets and stoppers





## Upper header sets and stoppers

Product Name	Dimensions
Acrylic counter leaflet holder, L-shaped, vertical	DL
Acrylic counter leaflet holder, L-shaped, vertical	A6
Acrylic counter leaflet holder, L-shaped, vertical	A5
Acrylic counter leaflet holder, L-shaped, vertical	A4
Plastic T counter stand for leaflet, vertical	DL
Plastic T counter stand for leaflet, vertical	A6
Plastic T counter stand for leaflet, vertical	A5
Plastic T counter stand for leaflet, vertical	A4
POS stand, low	A4
POS stand, high	A4
Clip frame wall-mounted, sharp corners	A4
Clip frame wall-mounted, sharp corners	A3
Clip frame suspended, sharp corners	A1
Clip frame suspended, sharp corners	A2
Clip frame suspended, sharp corners	A3
Attachment set for suspended clip frame	N/A
PET pocket for leaflet, self-adhesive	A1
PET pocket for leaflet, self-adhesive	A2
PET pocket for leaflet, self-adhesive	A3
PET pocket for leaflet, self-adhesive	A4
PET pocket for leaflet, self-adhesive	A5
PET pocket for leaflet, self-adhesive	A6
PET pocket for leaflet, self-adhesive	DL
Double-sided gel cardboard 33 m	15x1 mm
Double-sided foam cardboard 66 m	15x1 mm
Upper signage, suspended	1000 mm
Frame for signage	1000 mm
Frame attachment for stand UNI	
Hook for signage suspension UNI	
Upper signage fixed 1000 mm	
Attachment sheet for signage UNI	
ondola signage	800 mm
POS Grip T (Sára holder)	75x26 mm
Shelf stopper for PET stand	Small
Shelf stopper for PET stand	Large
Bracket for UNI stopper	
Hook for UNI stopper	



Sales stands

# Display table



Product Name	Dimensions
Permanent display table	D400
Permanent display table	D800
Permanent display table	D1200

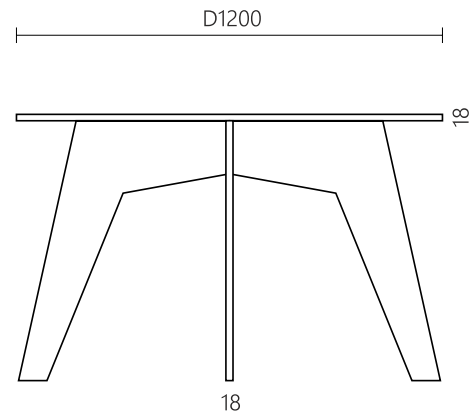
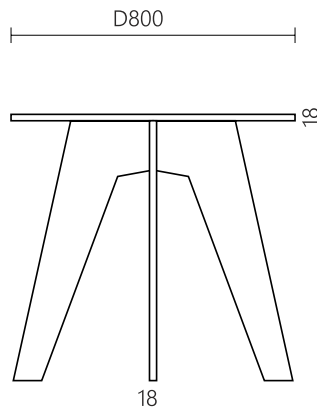
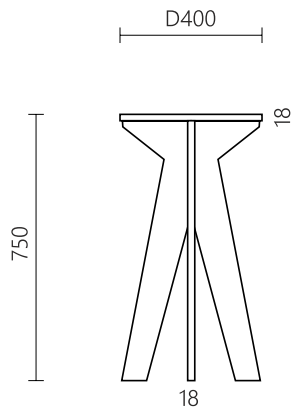

**MORIS**  
DESIGN

[www.moris.cz](http://www.moris.cz)  
[www.morisdiction.cz](http://www.morisdiction.cz)  
**+420 725 539 263**